

Engineered Driveline Connections

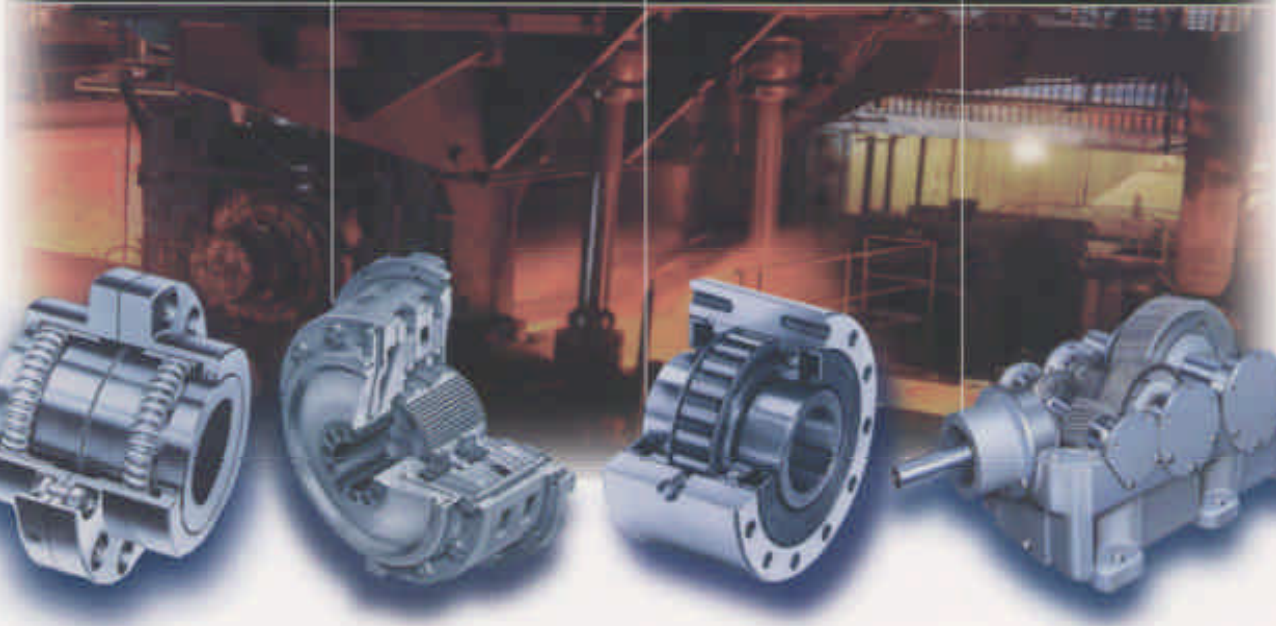

Ameridrives Couplings • Industrial Clutch • Marland Clutch
Nuttall Gear • Delroyd Worm Gear



MEX (55) 53 63 23 31 MTY (81) 83 54 10 18
QRO (442) 1 95 72 60 ventas@industrialmagza.com

Driveline Connections

December of 1996 marked the beginning of Ameridrives International with the purchase of four operations previously comprising the Mechanical Power Transmission Group of Zurn Industries Incorporated. The group included the Mechanical Drives Division, Erie, Pennsylvania, manufacturer of standard and high performance couplings, and Marland Clutch Division, LaGrange, Illinois, manufacturer of one-way and backstopping clutches. The new Ameridrives International, headquartered in Erie, Pennsylvania has specialized in the design and manufacture of mechanical power transmission products since 1928.

In May of 1997 Ameridrives International acquired Industrial Clutch Products of Waukesha, Wisconsin. Established in 1930, Industrial Clutch has designed and manufactured a complete line of quality friction clutches and brakes and specializes in custom hydraulics and controls.

Acquired in July of 1997, Nuttall Gear LLC of Niagara Falls, New York was added to complement the Ameridrives product offering. Nuttall Gear LLC, with over 100 years experience, continues to supply superior enclosed gear drives and gear services. The addition of Delroyd worm gear products in December of 1997 further expanded Nuttall's industry leading product line in power transmission equipment and packaged assemblies.

During 1998, Boston Gear and Ameridrives joined together functionally creating the foundation of a world class Power Transmission/Motion Control organization. As we prepare for the 21st century, Ameridrives affiliation with Boston Gear will enable us to focus on the strengths of these companies and brands. By leveraging the synergies among all operations, the Boston Gear family of companies will be able to serve our customers with the industry's broadest range of coordinated power transmission products and engineered drive connections.

With close to 500 years of cumulative experience, Boston Gear companies are recognized world wide as suppliers of high quality mechanical power transmission products. Industries serviced include petrochemical refining, power generation, ferrous and non-ferrous rolling mills, pulp and paper mills, mining and material handling and other general industrial applications requiring the efficient transmission of power. Although our names have changed, Boston Gear continues to offer the same quality products designed for long life and superior performance. Our engineering staff welcomes any opportunity to service your everyday needs or develop specialized products for difficult applications.

Table of Contents

	Brochure Number	Page
Coupling Products		
Amerigear Flexible Couplings.....	609-ADV.....	3
Amerigear Class I High Performance Couplings	462-ADV.....	4
Ameriflex Diaphragm Couplings.....	741-ADV.....	5
	749-ADV Metric	
Americardan Universal Joints	774-ADV.....	6
Amerigear Flexible Gear Spindles	747-ADV.....	7
Industrial Clutch Products		
Dry Clutches and Brakes	100-ICP-ADV.....	8
Oil Immersed Clutches and Brakes	100-ICP-ADV.....	9
Marland Clutch Products		
Automatic Backstops	415-ADV.....	10
CECON Completely Enclosed Clutches	421-ADV.....	11
Automatic Freewheel Clutches	463-ADV.....	12
Marland-RINGSPANN Freewheel Clutches, RMS, RMZ, RMX, FXM Series	753-ADV.....	13
Marland-RINGSPANN Freewheel Clutches, ZZ Series, R 200 Series	753-ADV.....	14
Nuttall Gear LLC		
Enclosed Gear Drives	N-100 and N-200	15
Moduline Concentric Gear Drives.....	N-100	16
Moduline Concentric Gear Drives.....	N-100	17
Delroyd Worm Gear Products.....	D-400 and D-500	18
Gear Drive Service	N-800	19

Information and specifications are subject to change.

Amerigear[®]

Flexible Gear Couplings

Ameridrives Couplings

Ameridrives International began manufacturing in 1928 as the Mechanical Drives Division of Zurn Industries. Through the years Ameridrives Couplings has pioneered many improvements for changing technologies of power transmission equipment. In the early 1950s Ameridrives Couplings patented the Amerigear fully crowned gear tooth coupling, the secret of superior mechanical power transmission. The basic gear coupling design was the stepping stone for the development of reliable and economical Amerigear Mill Spindles. Ameridrives Couplings introduced the Ameriflex non-lubricated diaphragm coupling in 1971 for the increased demands of high performance turbomachinery equipment. Since 1978 we have supplied high capacity industrial Universal Joints to round out our offerings for mill product applications. As a leader in power transmission equipment for over 70 years, Ameridrives Couplings is your single source for all your drive applications. Let us solve your Driveline Connections.

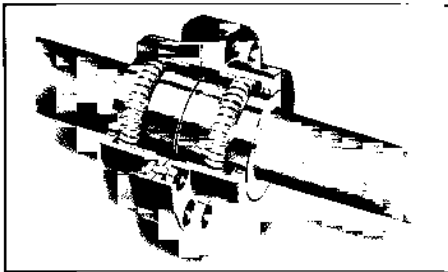

Amerigear Series F
Flanged Sleeve Flexible Coupling

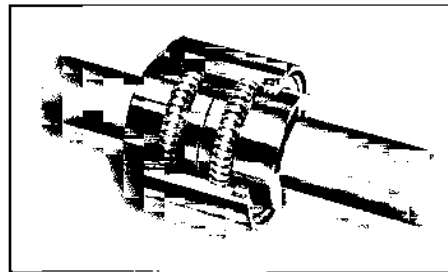

Amerigear Series C
Continuous Sleeve Flexible Coupling

Amerigear Couplings with Fully Crowned Teeth

In contrast with ordinary gear tooth forms, all three working portions of the tooth are crowned. The teeth act much like a rocking chair, capable of sliding freely in the axial direction without digging or gouging the internal mating teeth. Because of this design advantage, Amerigear offers operational benefits of maximum load-carrying capacity with minimum size, maximum reliability and long life.

F&C Sizes	Maximum Bore-in Square Key	Torque In.-Lbs. x10 ³
200	.81	1.9
201	1.25	3.2
201-1/4	1.63	7.6
201-1/2	2.25	17.0
202	2.75	31.5
202-1/2	3.50	53.6
203	4.00	94.5
203-1/2	4.50	142.0
204	5.50	214.0
204 1/2	6.25	324.0
205	6.63	416.0
205-1/2	7.50	551.0
206	8.25	750.0
207	9.63	1,033.0
208	11.25	1,500.0
209	12.25	1,700.0
210	13.75	2,080.0

Advantages and Features

- ±1 1/2° misalignment for sizes 200-207
- ±3/4° misalignment for sizes 208-210
- Maximum 60,000,000 in.-lbs. torque
- Original patented fully crowned gear teeth
- Proven reliability

Amerigear Coupling Series:

- F — Standard Sleeve
- C — Continuous Sleeve
- FS & CS — Single Engagement
- FM & CM — Mill Motor (Taper Shaft)
- FMS & CMS — Mill Motor Single Engagement
- FVS & CVS — Vertical Single Engagement
- FA & CA — Axial Travel
- FAS & CAS — Axial Travel Single Engagement
- FE — Extended (Spacer)
- FL & CL — Continuously Lubricated
- FEL — Extended, Continuously Lubricated
- FR — Rigid
- FD & FDC — Disconnect (Cut-out)
- FB & CB — Brake Drum
- FI — Insulated
- FPH — FPH — Shear Pin
- FI — Insulated
- FPH — Shear Pin
- FSPH — Shear Pin Single Engagement

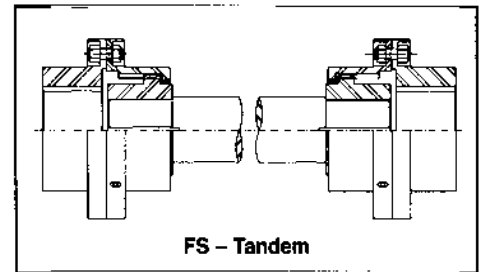

FS - Tandem

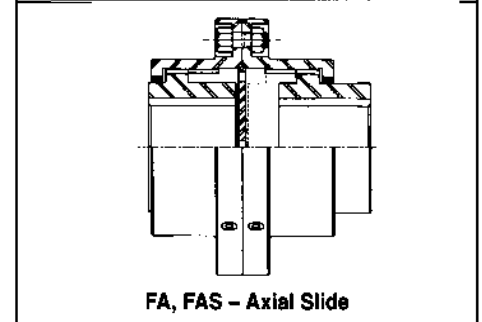

FA, FAS - Axial Slide

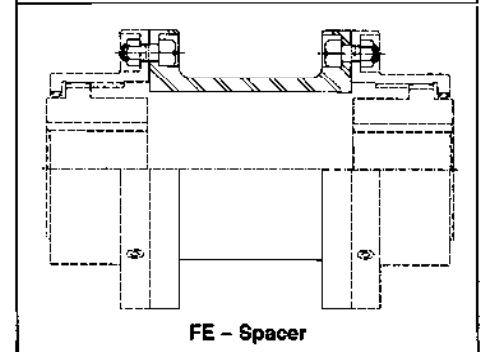

FE - Spacer

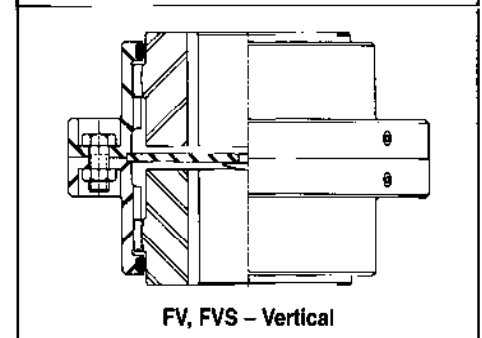

FV, FVS - Vertical

Request catalog 609-ADV



MEX (55) 53 63 23 31 MEX (81) 82 54 10 18
QRO (442) 1 95 72 60 ventas@industrialmagza.com

e-mail info@ameridrives.com

Amerigear®

High Performance Class I Gear Couplings

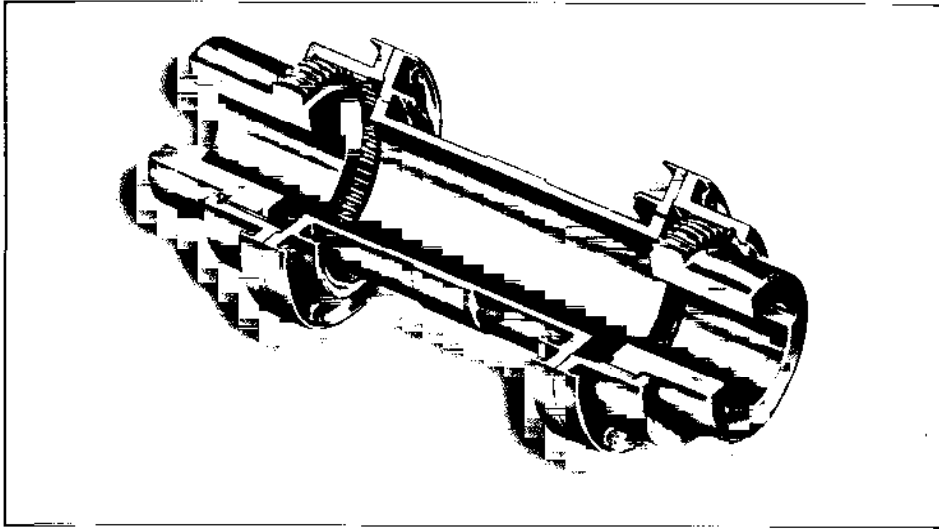

Class I FELE Style Coupling

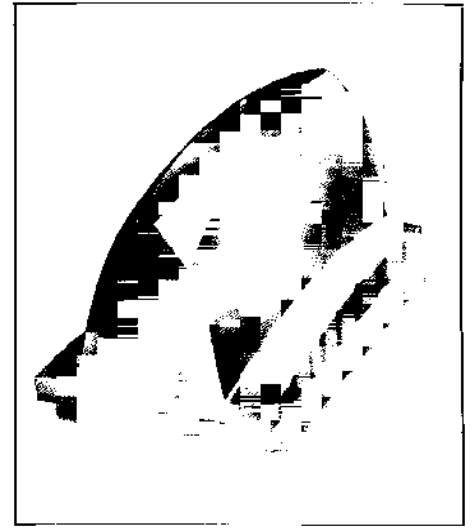

Amerigear Fully Crowned Gear Tooth

Amerigear Class I Couplings

Amerigear Class I High Performance Gear couplings with fully crowned gear teeth are designed for higher torque, higher speed, and higher misalignment to accommodate the increased performance demands of modern, rotating equipment. Ameridrives, the first to apply the fully crowned gear tooth concept to a gear-type coupling in the early 1950's, continues to offer Amerigear Class I couplings with high torque and high performance characteristics in relation to their size and weight.

Standard and custom designs are manufactured at Ameridrives to precision tolerances utilizing high quality steel and fasteners. Custom designs are available to meet your requirements for weight or size limitations, high temperature, high speed or extreme misalignment requirements. The gear tooth is fully crowned and can be designed to handle extreme misalignment requirements.

Advantages and Features

- Sealed lube and continuous lube designs
- Spacer, reduced moment and marine styles
- Shaft sizes to 12.00 inches in diameter
- Continuous torque to 1,750,000 in.-lbs.
- 1/4° standard to 7 1/2° custom misalignment
- AISI 4140 heat treat steel
- Nitrited gear teeth
- Twelve point grade 8 fasteners
- Good dynamic balance characteristics
- API 671 compliance optional
- Custom designs available

Styles

- **FE** Flanged Sleeve, Extended Spacer, sealed lubrication
- **FELE** Continuous Lubrication, oil is end fed, spacer discharged
- **FELC** Continuous Lubrication, oil is spacer fed, end discharged
- **RM** Reduced Moment, this design is used where a minimum of overhung moment is required because of system sensitivity
- **FE/RM** Sealed Lubrication/Reduced Moment spacer type
- **FELE/RM** Continuous Lubrication/Reduced Moment, oil is end fed, spacer discharged
- **FELC/RM** Continuous Lubrication/Reduced Moment, oil is spacer fed, end discharged
- **MS** Marine Style, this design is used where oversize bore capacity or flange-type mounting is required
- **FE/MS** Sealed Lubrication/Marine Style spacer type
- **FELC/MS** Continuous Lubrication/Marine Style, oil is spacer fed, end discharged

Request catalog 462-ADV

Ameriflex[®]

High Performance Multiple-Convolute Diaphragm Couplings

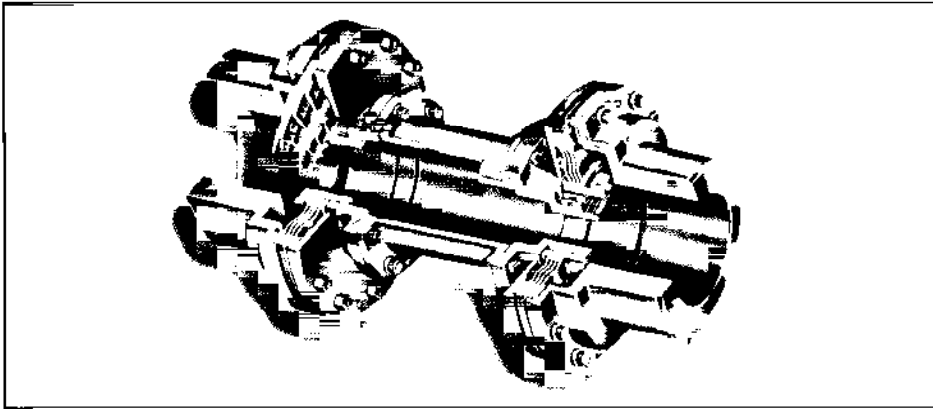

Ameriflex RR Series Coupling

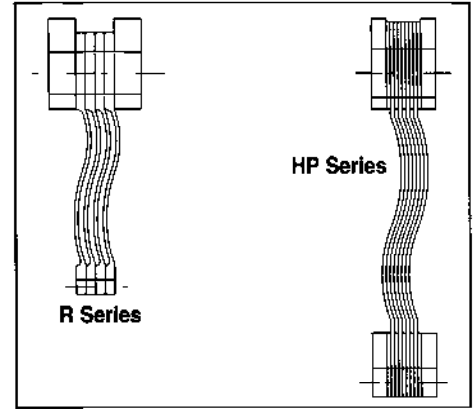

Diaphragm Pack Profile

Ameriflex Couplings

Designed specifically for the rigorous demands of the turbo-machinery industry, the Ameriflex multiple convoluted diaphragm coupling was introduced in 1971. Since that time, rotating equipment has continued to demand lighter weight and more powerful couplings. Ameriflex couplings are able to satisfy these demands and continue to set new standards for performance and reliability.

The patented multiple convoluted diaphragm design offers the lowest axial and bending stiffness of any diaphragm coupling available. This results in lower forces imposed from misalignment and axial travel on connected equipment's bearings, seals and shafts. The maintenance-free design requires no lubrication, making it the ideal choice for continuous duty critical applications.

The type of balance (component, assembly check, assembly balance or any combination) is completely the customer's choice. The absence of radial clearances means extremely low, repeatable unbalance regardless of the type of balance chosen.

Advantages and Features

- Maximum 6,000,000 in.-lbs. torque
- Axial travel to $\pm .875$ inch
- Angular misalignment to $1/2^\circ$
- Speeds to 30,000 RPM
- Shaft sizes to 21 inches
- High torque to diameter ratio
- High torque to weight ratio

- Low windage and horsepower loss
- Diaphragms designed for infinite life using Finite Element Analysis
- R Series integral filler diaphragm maintains diaphragm flex area separation with optimized convolution form
- Manufactured to API-671 requirements
- Low Bending Moment and axial force while maintaining high torque capacity, resulting in lower bearing loads
- Symmetrical diaphragm does not subject connected equipment to an alternating moment
- Large axial travel capability with constant axial stiffness
- Low repeatable unbalance
- Multiple separated diaphragms provide a built-in, fail safe feature
- Diaphragms are 15-5 PH stainless steel
- Shot-peened diaphragms for improved fatigue strength and stress corrosion resistance
- Diaphragms capable of operating without protective coatings
- Black oxidized, heat treated alloy steel torque transmitting components are standard
- Field replaceable sub-assemblies
- Maintenance-free
- Customized designs

Styles

- **RR Series (Reduced Ratio)** offers high torque and large bore capacity, with a light weight, low moment assembly.
- **RM Series (Reduced Moment)** provides a large bore and high torque capacity with the lowest overhung moment.
- **RS Series (Reduced Ratio Short)** maintains the high torque to bore ratio and the large axial travel capacity of the RR Series with a one piece center section.
- **HP Series (High Performance)** offers a longer flexing area and is used where large axial travel, angular misalignment or low stiffness are required.

Americardan™

Universal Joints

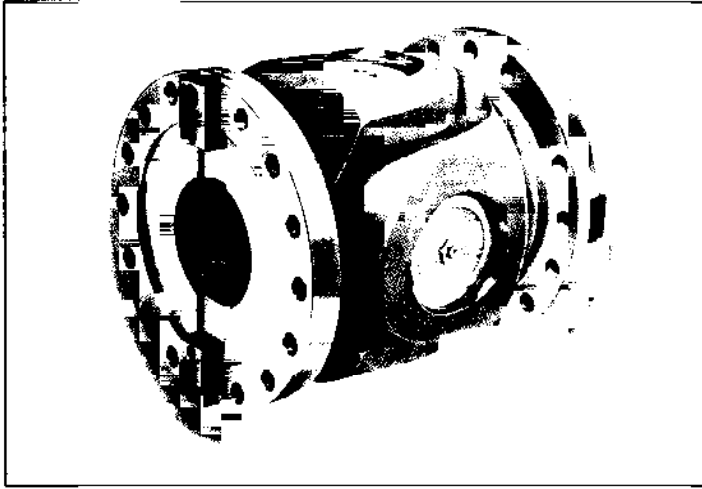

Americardan Universal Joints

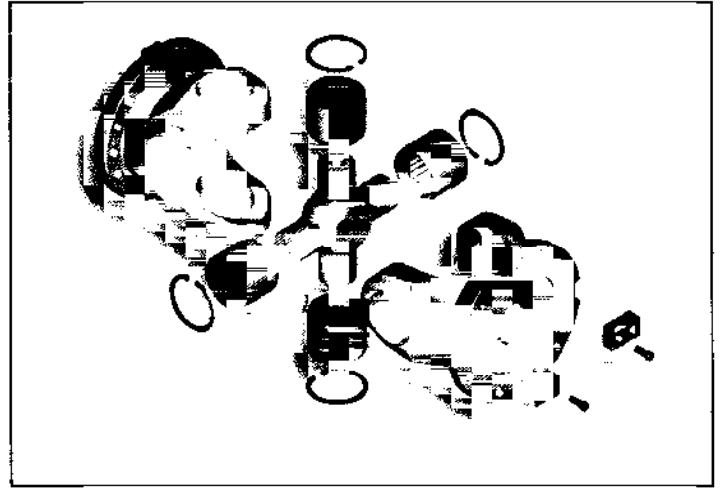

Universal Joint Components

Americardan Universal Joints

Used for torsionally rigid shaft connections, these drives can accommodate connection of shafts that may be parallel or inclined to each other, offset vertically or laterally.

Universal joints can also accommodate axial displacement, if supplied with telescoping splines.

The outstanding features and advantages of the Americardan universal joint design provide for a compact, long life, low maintenance universal joint.

Advantages and Features

- Torques to 30,000,000 in.-lbs.
- Up to 36 inches in diameter
- Misalignment to 15°
- Long bearing life
- One piece yoke and bearing housing construction
- Eliminates unnecessary bolted connections and serrations in yokes
- Heat treated alloy steel components

- Ideal loading across entire bearing length due to balanced deflection between yokes and cross
- Replaceable inner bearing race on size U3440 and larger significantly reducing cross-maintenance expenses
- Virtually no backlash compared to gear spindles and slippers
- Available in four basic types
- Technical support and engineering services available
- Extensive repair facility
- Special sizes and designs available upon request
- Large sizes available

Typical Applications

- Rolling Mills
(Steel, Aluminum, Copper, Brass)
- Bar, Rod, & Structural
 - Coilers
 - Cold Reduction Tandem
 - Hot Slab (Reversing)
 - Hot Strip
 - Temper & Skinpass
 - Tube, Pipe & ERW
 - Vertical Edgers
 - Winders & Unwinders

Styles

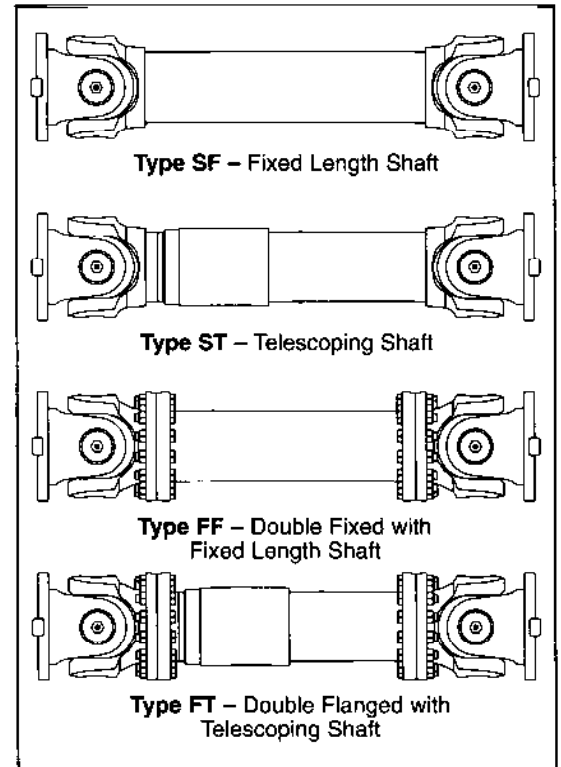

Request catalog 774-ADV.
(English and Metric)

Amerigear®

Flexible Spindles

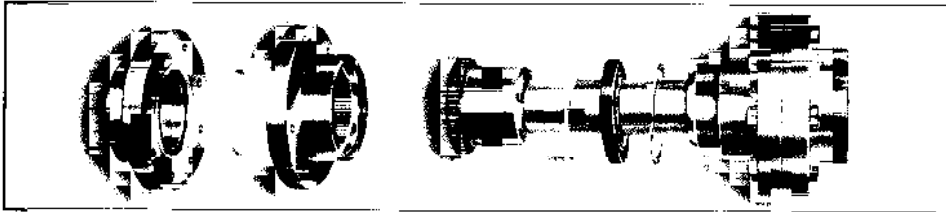

SF Flange Type

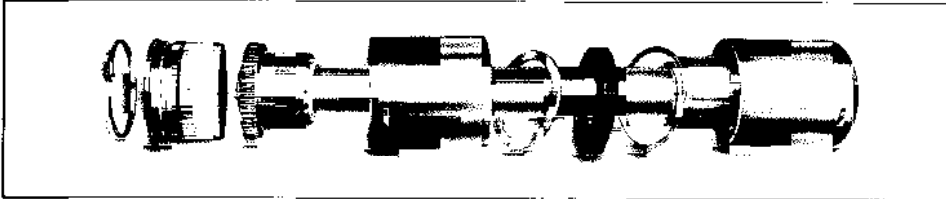

SL Leveler Type

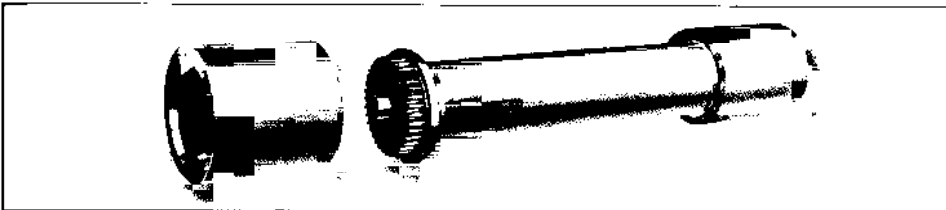

SM Mill Type

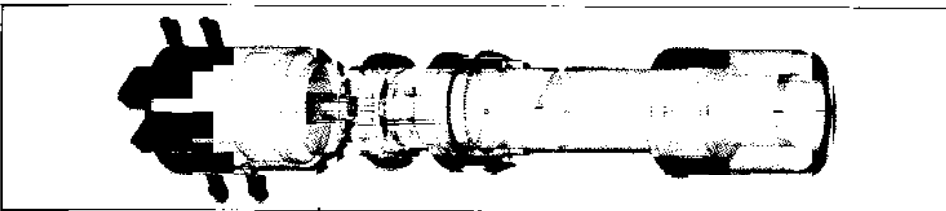

VL Mill Type

Amerigear Flexible Spindles

Since the commercial development of gear type spindles in the early 1950's, their use has been universally accepted on all types of mill drives.

There are other factors which underline the importance of gear type spindles in mill drives. Ever increasing demands for higher rates of production necessarily result in increasing demands for higher speeds, higher torques, improved rolled—product quality, less maintenance and minimum downtime.

Ameridrives International patented the crowned gear tooth, and now offers **Advanced Gear Design** (patent pending). This optimized geometry crowned gear tooth increases capacities up to 300% greater than previous designs for high torque, high misalignment applications and longer life. Their constant angular velocity at

misalignment angles ensures smooth power transmission, resulting in uniform size and improved surface quality of rolling mill products.

Advantages and Features

- Flange, Leveler and Mill types
- Misalignment to 6°
- Up to 40 inches in diameter
- Torques to 30,000,000 in.-lbs.
- Custom design
- Extensive repair facility
- Inherent dynamic balance characteristics
- Minimal vibration
- Increased operating life of connected equipment

Styles

The **SF Flanged Spindle** is for medium duty, medium torque applications where relatively high misalignment capacity is required and where equipment is **not subjected to frequent disconnection** of drive components.

The **SL Leveler Spindle** is for medium duty, medium torque applications where relatively high misalignment capacity is required and **where equipment is disconnected quickly and/or frequently**.

The **SM Mill Spindle** is used on heavy-duty, high-torque applications requiring rugged strength such as metals rolling mill main drives and similar heavy equipment.

The **VL Mill Spindle** is used on medium to heavy duty metals rolling main drives and auxiliary equipment.

Typical Applications

Rolling Mills
(Steel, Aluminum, Copper, Brass)

- Bar & Rod Mills
- Cold Reduction
- Hot Slab (Reversing)
- Hot Strip
- Temper
- Tube Mills
- Vertical Edgers

Strip Treating Lines
(Anneal, Pickle, Galvanize, Cleaning)

- Bridles
- Brush Rolls
- Coilers
- Flatteners
- Pinch Rolls
- Scale Breakers

General Applications

- Steckel Mill Feed Rolls
- Continuous Casting Equipment
- Cranes
- Levelers
- Shears, Side Trimmers, Slitters
- Paper Mill Machinery
- Plastic and Rubber Calender Rolls
- Rotary Side Guides
- Runout Tables
- Straighteners (Tube, Beams, Bar)
- Tension & Payoff Reels

Request catalog **747-ADV**

Clutches, Brakes, Controls, Hydraulics

Industrial Clutch

Established in 1930, Industrial Clutch has designed and manufactured a complete line of dry and oil-immersed clutches and brakes, ranging in size from 8 to over 42 inches in diameter, with torque capacities exceeding four million pound-inches. We also specialize in hydraulics and controls for use with our clutches and brakes.

We pride ourselves in our ability to respond to customer needs for standard, modified, and custom designs for unique or volume development programs and full scale testing. We are committed to producing world class clutches and brakes for an international industrial market.

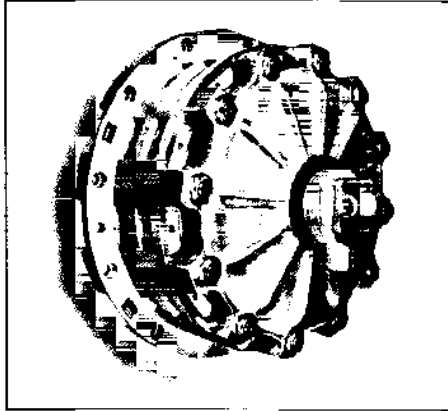

Model LK

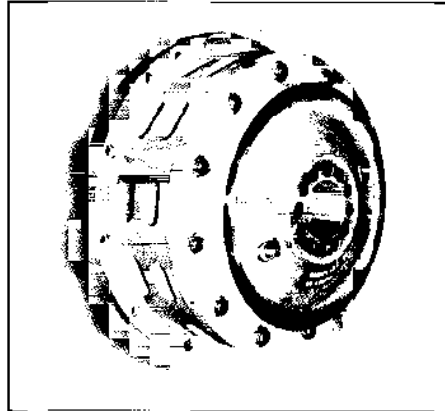

Model LKB

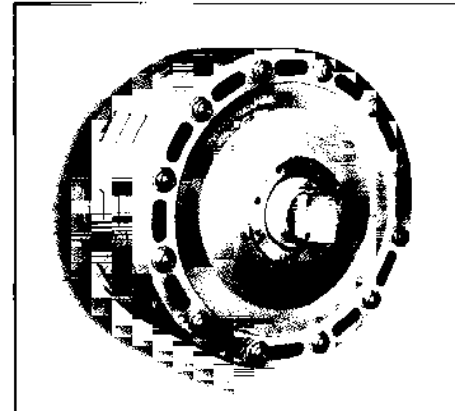

Model LKM

Dry Clutches and Brakes

Industrial Clutch manufactures a complete line of dry disc type clutches and brakes. These units offer a reliable and economical method for power transmission. The basic design has been proven through time and may be customized to meet the individual needs of the customer's application. Many additional features and options are also available.

Model LK

The Model LK clutch is a low driven inertia air set clutch. It may be used with a standard rotary seal or with Industrial Clutch's rotary seal and quick exhaust. Assembly sizes range from 8" to 48" with torque capacities from 5,000 to 9 million lb.-in.

Model LKB

The Model LKB spring set air released brake is the ideal companion to our model LK clutch. This unit is ideal for high energy emergency stop applications or as a holding brake. It can be furnished with metallic or non-asbestos organic linings. Sizes range from 8" to 48" with torque capacities from 1,500 to 1.3 million lb.-in.

Model LKM

The Model LKM marine clutch is designed to handle the severe engagements and extended running periods for the marine industry. All LKM Clutches include "positive plate separation" to eliminate drag while disengaged.

Advantages and Features

- Ease of maintenance
- Low driven inertia
- Quick response
- Low spline stresses
- Enclosed drive ring
- Pneumatic or hydraulic actuation/release
- Monitoring and adjustment options

Styles

- Air Clutches
- Air Brakes
- Spring Set Brakes
- Tension Brakes
- Hydraulic Clutches
- Hydraulic Brakes
- Oil Immersed Combination Clutch/Brakes

Applications

- Metal Forming
- Mining
- Marine
- Petroleum
- Lumber
- Paper
- Custom Designs

Request catalog 100 ICP-ADV

Clutches, Brakes, Controls, Hydraulics

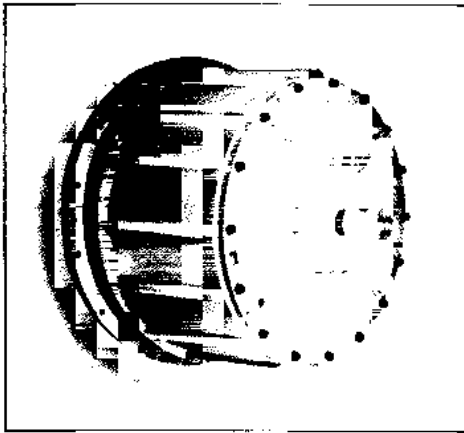

Model CBA

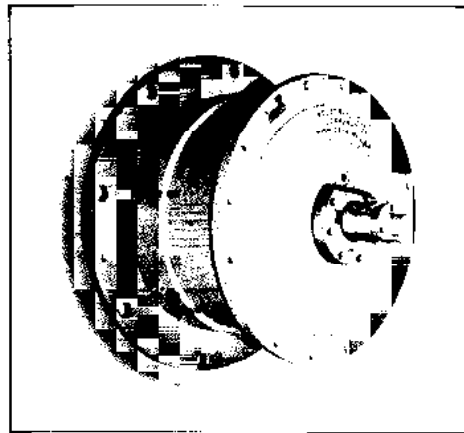

Model CBH

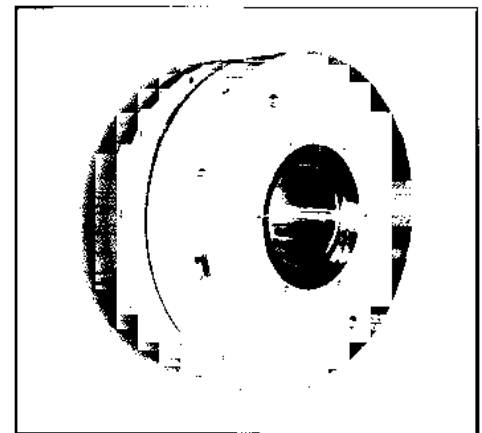

Model HBA

Oil Immersed Clutches and Brakes

Industrial Clutch manufactures a complete line of both wet and dry clutches and brakes. The wet or immersed units have repeatedly demonstrated their superior ability to operate with greater longevity and accuracy than their dry counterparts by a factor of five to ten times.

These units are capable of running at higher speed and greater cyclic frequencies without exhibiting the wear magnitudes common to dry units under the same conditions. The oil immersed clutches and brakes offer another viable alternative when unusually tough and demanding applications are encountered.

Industrial Clutch has designed their oil immersed units to complement their dry units. In doing so, they are able to offer a wide range of choices to today's most sophisticated equipment.

Model CBA

The Model CBA combination clutch/brake is available with either air or hydraulic actuation. The CBA is a quill mounted unit that may be used for either end of shaft or thru-shaft designs.

Model CBH

The Model CBH combination clutch/brake is an oil-immersed, hydraulic actuated unit designed for end of shaft mounting. It is capable of high cycle rates with extreme accuracy. Ideal for turret punch press conversions.

Model HBA

The Model HBA brake is an oil-immersed, air or hydraulic actuated brake designed for use on a drive train shaft extension. The Model HBS is a spring set alternative.

Advantages and Features

- Reliability
- Long life
- Extreme accuracy
- Low driven inertia
- Quick response
- Impervious to adverse operating environments

Styles

- Air Clutches
- Air Brakes
- Spring Set Brakes
- Tension Brakes
- Hydraulic Clutches
- Hydraulic Brakes
- Oil Immersed Combination Clutch/Brakes

Applications

- Metal Forming
- Mining
- Marine
- Petroleum
- Lumber
- Paper
- Custom Designs

Automatic Backstops

Marland Clutch

Since 1931, Marland has been producing backstops, clutches and clutch couplings based on their one-way clutch design, utilizing the principle of cylindrical rollers on inclined cam planes. This design has proven its dependability in worldwide installations ranging from food processing plants to equipment used in steel mills and heavy mining industries. For over 60 years, Marland has been the recognized leader in design and manufacture of freewheeling clutches.

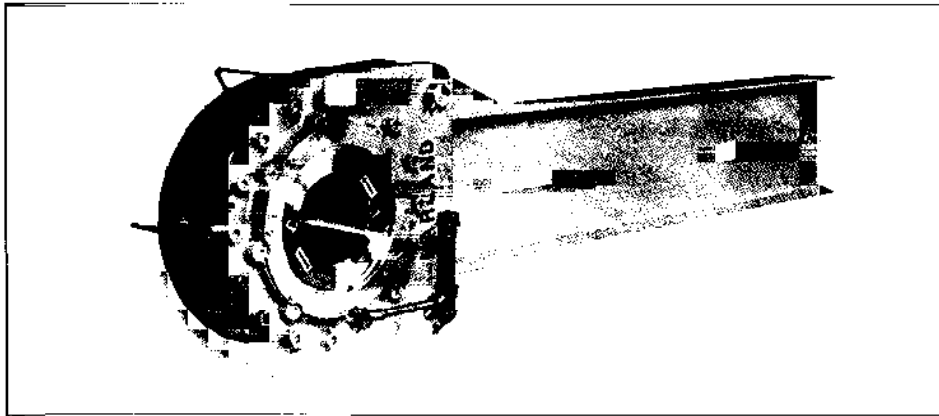

Marland Automatic Backstop

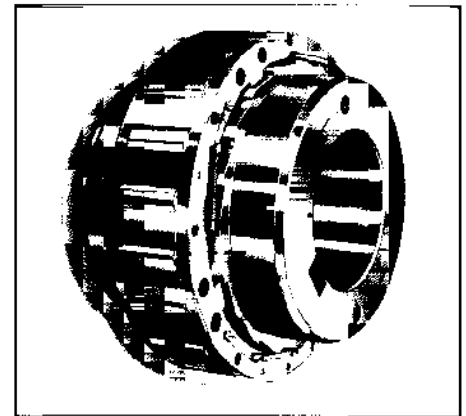

Backstop mechanism revealing cam and roller cage detail.

Marland Automatic Backstops

Marland Automatic Backstops provide positive protection against reverse torque runaways of inclined conveyor or elevator installations assuring the safety of operating personnel. Factors to consider when applying Marland Backstops are:

- The causes of reverse torque loading conditions
- The importance of installing backstops on low speed headshafts—where reverse torque loads originate
- Use of sound methods for selecting backstop sizes, based on many years of successful installations, rather than theoretical reverse torque calculations
- The basic design, operating principle and uniformly high torque capacity of Marland One-Way backstops
- The simple maintenance and lubrication requirements of the Marland design

Advantages and Features

- Long service life
- Lower stresses
- Full contact
- Taconite seals
- Positive triple sealing
- Removable torque arm
- Superior roller design

Engineering Data

Backstop Size	Rated Torque Lb. Ft.	Max. R.P.M.	Max. Bore
3MA	3,000	300	2-15/16
6MA	6,000	250	3-11/16
12MA	12,000	210	4-1/2
18MA	18,000	180	5-7/16
27MA	27,000	150	6-1/2
45MA	45,000	135	7
63MA	63,000	120	8
90MA	90,000	105	9
135MA	135,000	90	10
180MA	180,000	80	11-3/4
240MA	240,000	70	14
375MA	375,000	60	18
540MA	540,000	60	21
720MA	720,000	60	21

Request catalog 415-ADV

CECON

Completely Enclosed One-Way Clutch for Continuous Operation

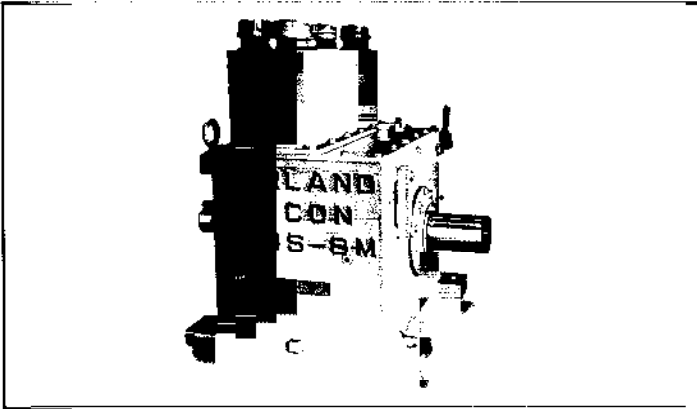

CECON Type CEUS

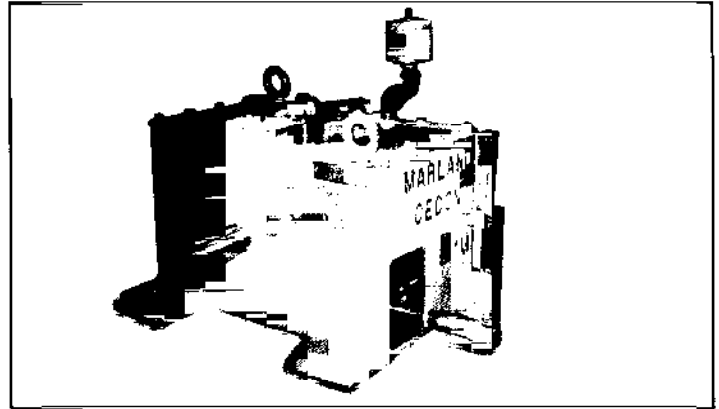

CECON Disconnect Type CEUSD/CEUHS

Marland One-Way CECON Clutches

Designed for applications where one or more of the following conditions exist:

- Shaft speeds exceed the permissible maximum for standard clutches, clutch couplings or backstops.
- Uninterrupted, continuous operation is required.
- Operation under extremely wet, dusty, abrasive or other adverse atmospheric conditions; or on unprotected outdoor applications; or subject to high ambient temperature.
- Shaft axis is not horizontal, as on cement kiln drives.
- Lubrication maintenance must be provided on a no "down-time" basis.

Advantages and Features

- Minimum maintenance
- High speeds
- Continuous operation
- Operates in adverse atmospheres
- Reduced downtime
- Long service life

Both CEUS and CEUHS CECONS are available with a disconnect feature that provides physical separation of the input and output shafts. This allows maintenance to be performed on the non-energized driver while the disconnect CECON is locked out in the disconnect position.

Additional CECON Disconnect Advantages and Features

- View port which allows visual confirmation of disconnect/connect status
- Full-speed testing of isolated equipment prior to reconnection
- Direct replacement for existing CEUS and CEUHS units

Applications:

- Dual Drives
- Creep/Inching Drives
- Turning Gear Drives
- Energy Recovery Systems
- Emergency Drive Kilns
- High Speed Backstops
- Barring Mills
- Reverse Torque Control

Engineering Data

CECON Clutch Type	CEUS	Rated Torque lb.-ft.	Capacity HP per 100 RPM	Maximum RPM	
				Type CEUS	Type CEUHS
5C		500	9-1/2	6,000	N/A
1M		1,000	19	5,600	12,000
2M		2,000	38	4,200	10,000
4M		4,000	76	3,600	8,000
8M		8,000	152	3,000	7,000
12M		12,000	229	2,500	6,000
18M		18,000	343	2,300	5,000
30M		30,000	571	2,000	4,500
42M		42,000	800	1,700	4,000
60M		60,000	1143	1,400	3,500

Request catalog 421-ADV

Automatic Freewheel Clutches

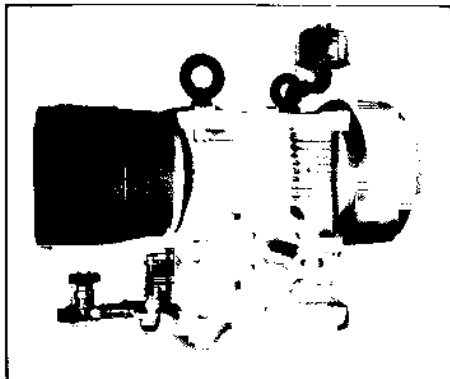

CEBMAG

CEBMAG

Marland CEBMAG mounted onto an emergency drive acts as a releaseable torque absorbing backstop clutch to gently release great loads, such as a cement kiln reversal.

Advantages and Features

- Completely Enclosed
- Long Service Life
- Continuously Self Lubricated
- Two Brakes
- Eliminate Risk of Centrifugal Explosion

Engineering Data

CEBMAG Backstop Size	Rated Torque Capacity lb.-ft.
5C-W	500
1M-W	1,000
2M-W	2,000
4M-W	4,000

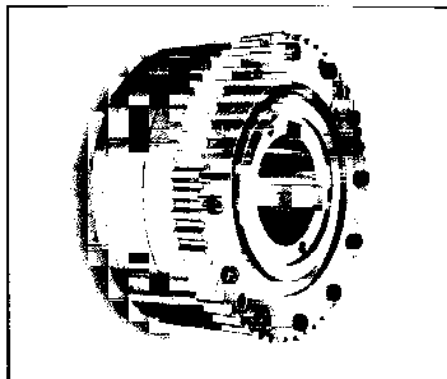

HB Clutches

HB Clutches

Automatic freewheel clutch mounted on hydrodynamic brake. Allows brake to work only when lowering loads from drawworks cable reel.

Advantages and Features

- Uniform Load Distribution
- No Loose Parts
- No Backlash
- Long Service Life
- Superior Roller Design

Engineering Data

Size	Rated Torque lb.-ft.	Max. Bore and Keyway	
		Straight Bore*	Keyway at Max. Bore
12MA	12,000	4-1/2	1 x 3/8
18MA	18,000	5-7/16	1-1/4 x 7/16
27MA	27,000	6-1/2	1-1/2 x 1/2
45MA	45,000	7	1-3/4 x 9/16
63MA	63,000	8	2 x 11/16
90MA	90,000	9	2-1/2 x 3/4
135MA	135,000	10	2-1/2 x 7/8
180MA	180,000	11-3/4	3 x 1

* For the taper bore: The largest diameter must not exceed the maximum straight bore dimension

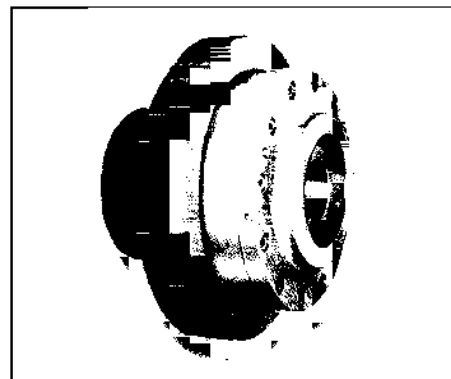

Clutch Couplings

Clutch Couplings

Marland Clutch Couplings provide positive, instantaneous driving or free wheeling action. The superior Marland design offers dependable trouble free operation while providing a 100% torque transmission with no slippage.

Advantages and Features

- Long Service Life
- Superior Roller Design
- No Loose Parts
- Automatic Instantaneous Action
- Fully Phased

Engineering Data

Clutch Coupling Size	Capacity HP per 100 RPM	Max. RPM
F1M	19	2,200
F2M	38	2,000
F4M	76	1,800
F8M	152	1,750
F12M	229	1,600
F18M	343	1,350
F30M	571	1,200
F42M	800	900
F60M	1,143	750
F90M	1,715	600
F120M	2,286	500

Request catalog 463-ADV

Marland-RINGSPANN

Freewheel Clutches

In 1985, under license agreement with RINGSPANN GmbH, Bad Homburg Germany, Marland acquired sprag technology from one of the leading manufacturers of freewheeling clutches. German engineering and American ingenuity are combined to bring you the finest, most durable, and most adaptable clutches on the market.

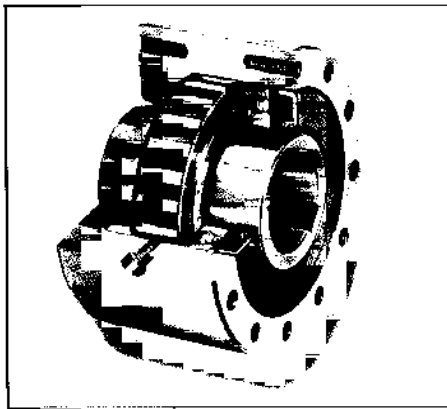

RMS Clutch

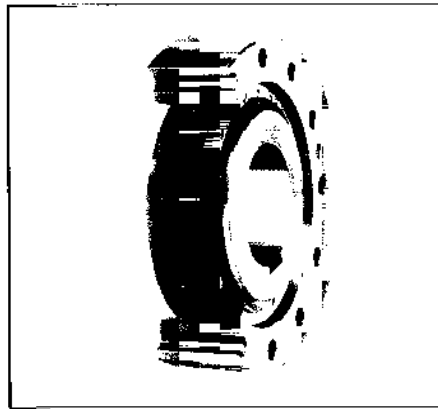

FXM Backstop

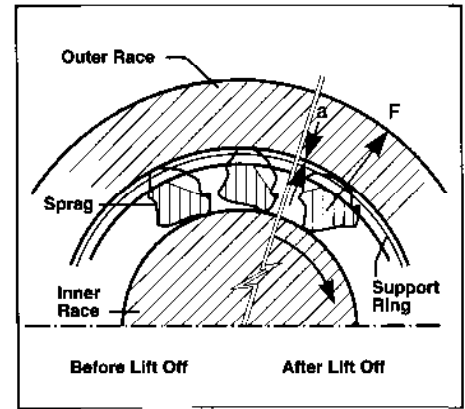

Lift-Off X

The RMS, RMZ and RMX Series

The RMS, RMZ and RMX series serve different fields of applications: The RMS models are general purpose clutches used for overrunning, backstopping and indexing applications. The RMZ and RMX models use lift-off sprags and are used in high-speed overrunning with low speed driving applications to minimize wear. The RMS, RMZ and RMX series free-wheels have a bolt circle on their outer race to which pulleys, gears and torque arms can be mounted. They are mounted onto shafts which may be of any diameter up to and including the maximum shown. Keyways are provided.

Advantages and Features

- Self-contained freewheels
- Overrunning, backstopping and indexing
- Lift-off non-wearing models available
- Oil or grease lubricated
- Manufactured in the U.S.

RMS Engineering Data

Size	Max. Bore in.	Outside Diameter in.	Length thru Bore in.
14	.875	3.500	2.75
18	1.125	3.500	2.75
21	1.312	4.250	3.50
26	1.625	4.750	3.25
32	2.000	5.375	3.75
40	2.500	6.500	3.50
47	2.937	7.125	5.00
55	3.347	8.750	6.00
72	4.688	10.000	6.00

The FXM Series

The FXM Series features a sprag backstop that is made for an overrunning inner race and has sprags that lift-off of the outer and inner races at high speeds. This unique lift-off feature is called "lift-off X".

The FXM Series is designed to be built into your equipment on the high speed or intermediate shaft where the torque is lowest. The freewheel inner race is put on the shaft and the freewheel outer race is fixed to the housing. This provides a space and cost savings over backstops that are mounted on the outside of your equipment.

FXM Engineering Data

Model	Max. Bore in.	Width in.	Outside Diam. in.	Torque Rating lb.-ft.
FXM 38 D	0.875	1.250	3.500	140
FXM 51 D	1.375	1.375	4.125	510
FXM 61 D	1.750	1.125	4.750	430
FXM 66 D	1.875	1.375	5.250	820
FXM 76 D	2.125	1.375	5.500	1,150
FXM 86 D	2.500	1.575	5.938	1,380
FXM 101 D	2.937	1.575	6.875	1,770
FXM 100 S	3.000	2.000	7.500	2,500
FXM 120 S	3.625	2.756	8.250	6,150
FXM 140 S	4.125	2.756	9.625	7,800
FXM 170 S	5.000	3.150	11.438	17,400
FXM 200 S	5.875	3.150	12.250	22,800
FXM 240 U	7.250	5.000	16.625	73,750
FXM 310 U	9.375	5.000	19.625	139,350

The FXM Backstop and RMX Series, utilizing the unique "lift-off", is made for applications which require low driving speeds and high speed overrunning inner race. The cross section above shows the left side freewheel at rest. The right shows the freewheel with centrifugal "lift-off X" in overrunning inner race condition. This design creates clearance dimension "a" between the outer race and the sprag during high overrunning speeds with the benefit of no contact or wear between sprags and the outer race.

Advantages and Features

- Non-wearing locking elements
- "Built-in" design for low cost, easy installation and no extra maintenance
- Custom designs available to fit the toughest applications
- Manufactured in the U.S.

Request catalog 753-ADV



MEX (55) 53 63 23 31 MTY (91) 89 54 10 38
QRO (442) 1 95 72 60 ventas@industrialmagza.com

e-mail info@marland.com

Marland-RINGSPANN

Freewheel Clutches

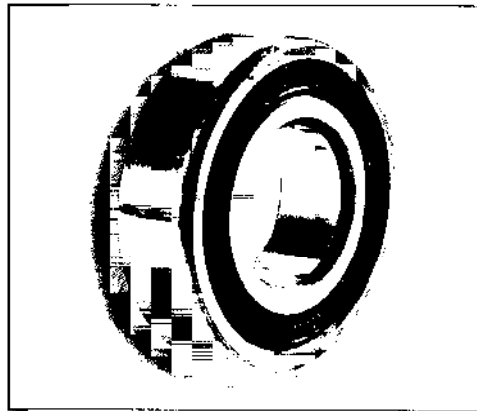

ZZ Freewheel

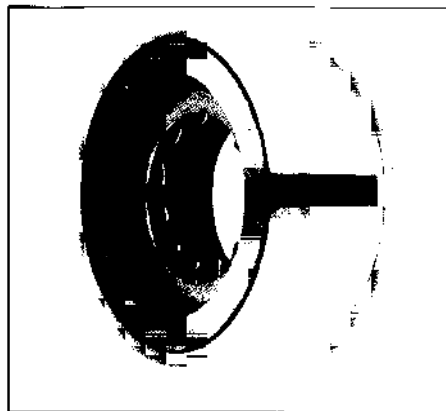

R 200 Clutch

The ZZ Series

The ZZ Series freewheel is the economical solution. It provides you with a one-way clutch, and eliminates the need for a ball bearing. It gives a high degree of freewheeling accuracy while utilizing a minimum of space.

Advantages and Features

- Same dimensions as Type 6200 ball bearings
- Overrunning, backstopping and indexing
- Maintenance free sealed grease filled design

ZZ Engineering Data

Model	Max. Bore in.	Width in.	Outside Diam. in.	Torque Rating lb.-ft.
ZZ6202M	.590	.433	1.378	12
ZZ6203M	.669	.472	1.575	16
ZZ6204M	.787	.551	1.850	33
ZZ6205M	.984	.590	2.047	50
ZZ6206S	1.181	.630	2.411	74
ZZ6206/25S	.984	.630	2.441	74

The R 200 Series

The R 200 Series sprag clutches are designed to be mounted in a housing (with a keyway on their outer race) and engage directly onto a hardened shaft. In service they may be lubricated by either oil or grease.

R200 Engineering Data

Size	Torque lb.-ft.	Width in.	Outside Diam. in.	Shaft Diam. in.
R204	66	1.000	1.8498	.740
R205	110	1.000	2.0463	.930
R206	195	1.125	2.4403	1.290
R207	325	1.125	2.8341	1.657
R208	450	1.250	3.1491	1.841
R210	620	1.250	3.5428	2.209

Typical Clutch Functions

Freewheeling

Anytime there is a difference in speed between the inner and outer races of a clutch, a freewheel or overrunning condition exists.

▪ Starter Drive Application

The clutch automatically engages as a starter motor cranks an engine. When the engine starts the clutch overruns allowing the engine to speed up. The clutch freewheels when starter motor is disengaged.

▪ High Inertia Drive Application

When the drive is started, the clutch engages and rotates the load up to speed. When the drive is shut off it can stop while the load continues to rotate and coast to a stop as the clutch freewheels.

Backstopping

When one race is fixed to a stationary member, the other race can only rotate in one direction. In this way the clutch can be used as a backstop.

▪ Inclined Conveyor Application

In this application, the outer race is secured by a torque arm. The inner race is attached to the head shaft and free to rotate in the up direction. If the conveyor tries to reverse, the clutch engages and prevents conveyor rollback.

▪ Fan Drive Application

The clutch has its outer race secured. The fan motor can rotate the fan in one direction while the clutch freewheels. When the fan motor is shut off, reverse direction called windmilling is prevented by the auto engagement of the clutch.

Request catalog 753-ADV

Enclosed Gear Drives

Nuttall Gear

From our modest beginnings as a privately owned company in 1887 and a division of Westinghouse Electric Corporation from 1928 to 1982, Nuttall Gear has continued to be a leader in innovation and excellence in the design and manufacture of industrial power transmission components and systems.

Today, Nuttall Gear is part of a corporation that includes complementary products from parallel shaft, concentric shaft, and worm gear reducers to couplings and clutches. Truly, Nuttall has evolved into a company that is your TOTAL DRIVE SOURCE.

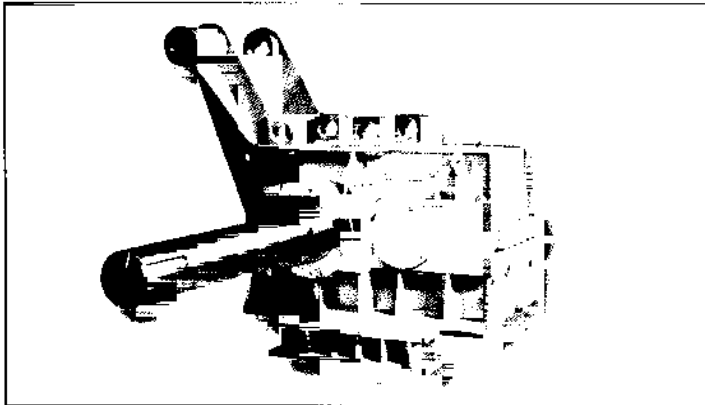

Recoiler

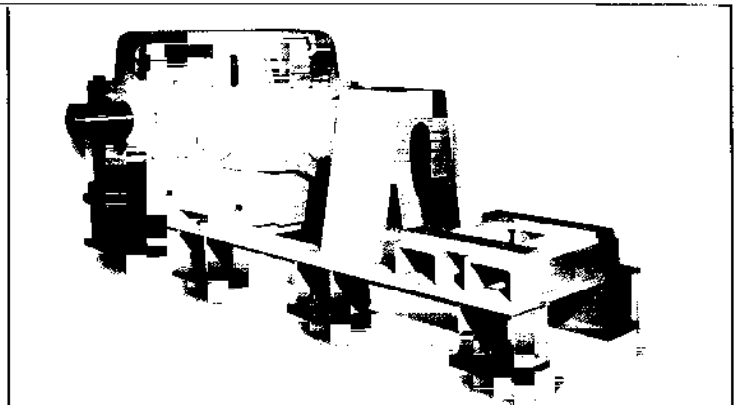

Type TDS Right Angle Reducer and Bedplate

Enclosed Gear Drives

Nuttall Gear drives are custom built for years of dependable operation with our commitment to excellence in both products and service. With over 110 years of experience we pride ourselves in knowing that we can handle the toughest custom job you may have. We will supply an enclosed gear drive to suite any special requirements you have. We coordinate your entire mechanical and electrical drive package. You receive it ready to run, not ready to assemble.

Types

- Type TDS Parallel and Right Angle Shaft Speed Reducers
- Type SU/SD High Speed Gears Drives (API-613, API-677 and AGMA 6011)
- Type RV Right Angle Vertical Speed Reducers
- Veri-Dri Vertical Concentric and Parallel Shaft Drives
- Metals Industries Gear Drives
- Custom Engineered Drives

Applications

Commercial, Industrial, Utilities, Transportation

- Ferrous and non-ferrous rolling mills (Pinion Stands, Mill Drives)
- Metal Process Drives (Recoilers, Levelers, Bridles)

- Mining and Material Handling
- Offshore Drilling Rigs
- Paper Processing Equipment
- Petrochemical Refineries
- Pumps, Fans, Compressors
- Power Generation
- Textile Processing Equipment
- Water Treatment Equipment
- Cooling Towers
- Hydro and Wind Turbines
- Elevators, Cranes, Hoists, Conveyors

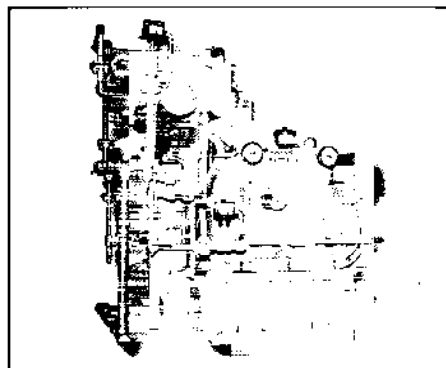

High Speed Double Helical Drive
(per AGMA or API)

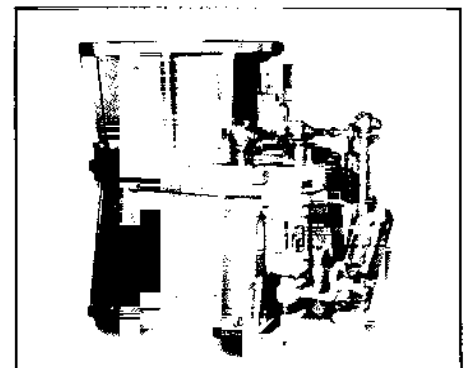

Veri-Dry Vertical Parallel Shaft



Combination Reducer Pinion Stand

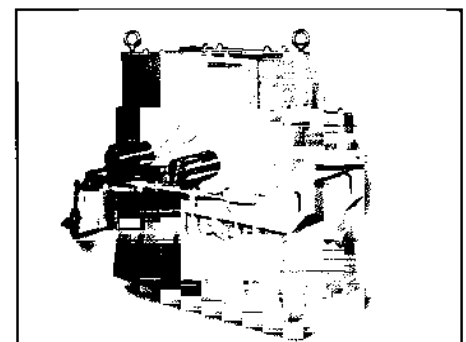

Custom Dual Output Shaft Drive

Request Catalog N-100 and N-200



MEX (55) 53 63 23 31
QRO (442) 1 95 72 60

MTY (81) 83 54 10 18
ventas@industrialmagza.com

e-mail nuttall@nuttallogear.com

Moduline[®]

Concentric Gear Drives

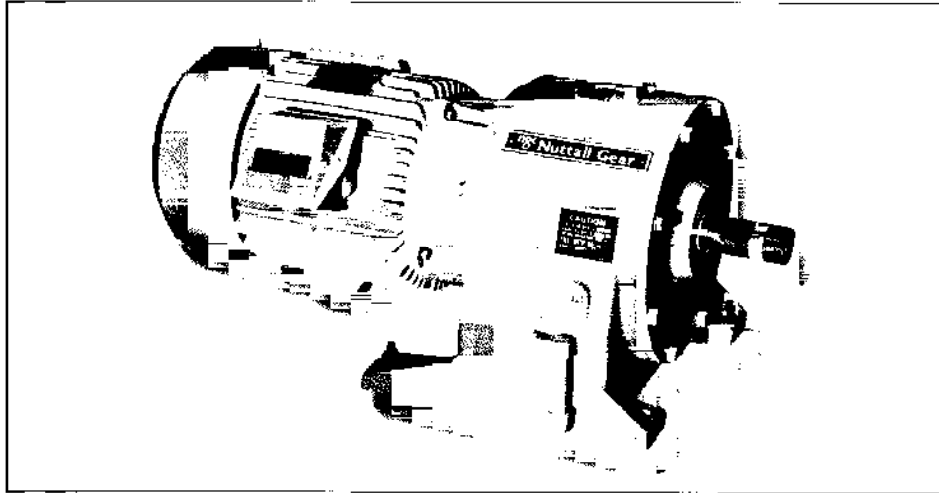

Integral Gearmotor

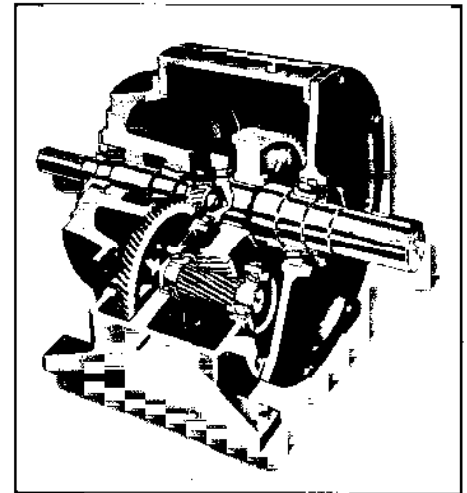

Concentric Gear Drives

Moduline—Designed for Versatility, Crafted for Durability

The Moduline family is a complete line of concentric shaft, helical gear, speed reducers. Integral Gearmotor, NEMA "C-face" Scoop Mount, piggyback and free-standing models are readily available. The Moduline design embodies the structural integrity and design conservatism that makes it the first choice in those industries where downtime carries a heavy penalty; industries such as steel manufacture, metal forming, chemical processing, petroleum, paper processing, and mining.

Advantages and Features

Reducer

- Gearing is Thru-Hardened for maximum resiliency to shock loads and then Ion Nitrided to provide a long life wearing surface.
- Rigid Cast Iron Housings provide maximum structural support for precise alignment of critical rotating components. Precise shaft alignment and stability assures long bearing and gear life.

- Timken[®] Tapered Roller bearings are used throughout for maximum thrust and overhung load capacity.
- Tough, Chrome-Moly, alloy steel shafting supplies maximum stabilization of gear mesh and minimum shaft deflection for proper bearing alignment.
- Precisely machined shaft surfaces and double lip oil seals assure that the oil stays in and contaminants stay out.

Integral Motor

- Purgative Grease Seals for maximum bearing protection against contaminants.
- Cast Iron construction for frame, conduit box, end shields, and fan cover.
- Extra large, diagonally split, neoprene gasketed, rotatable conduit box.
- U.L. Approved, clamp type grounding lug and stainless steel "T" drains.
- Corrosion resistant, polypropylene fan

Types

- Single, Double, Triple, and Quadruple Reductions are available
- Ratios from 1.225:1 to 985.3:1
- Maximum Torque to 250,000 in.-lbs.
- Integral Gearmotor
- Scoop Mount Gearmotor
- Piggyback Gearmotor
- "C-Face" Gearmotor
- Free Standing Reducer
- "Dry Well" Reducer or Gearmotor
- Bedplated Reducer

Request Catalog N-100

Moduline®

Concentric Gear Drives

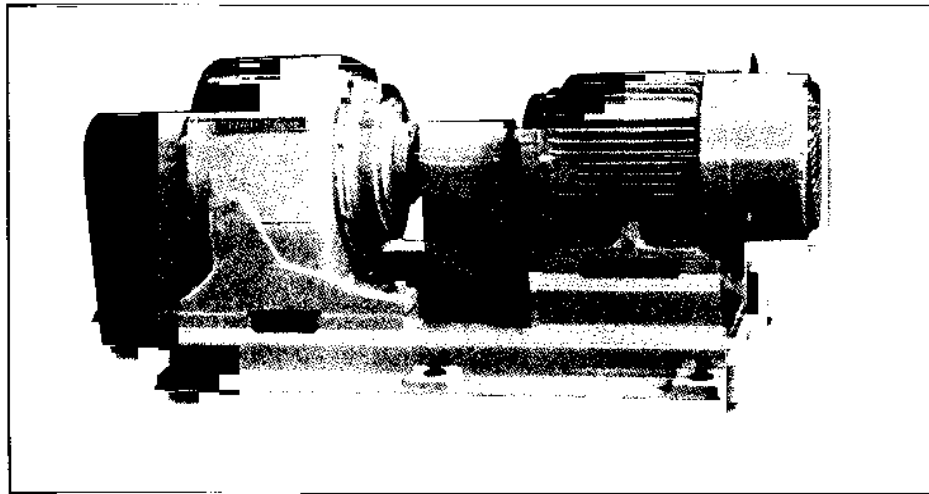

Base-Mounted Gearmotor



Cross Collector

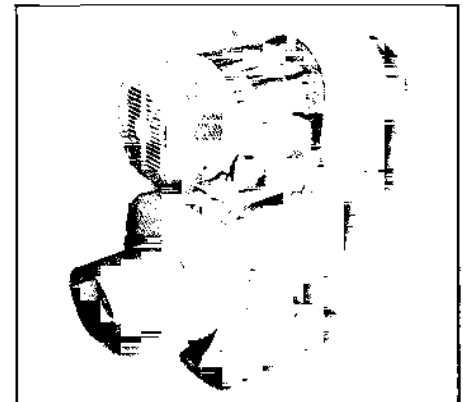

Piggy Back

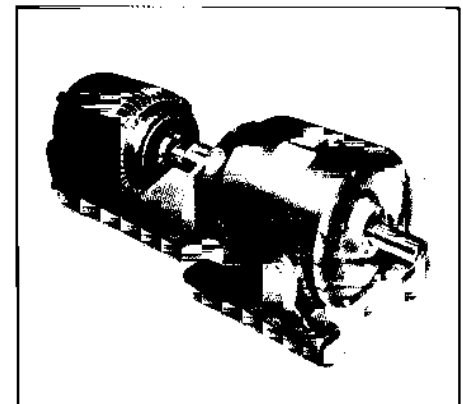

"All Motor" Scoop Mount Gearmotor

Modifications

Reducer

- Special low speed shafts
- Output flange assemblies
- Right angle output heads and cross-collector drives
- Special mounting positions
- Low backlash gearing
- Backstops
- Soft start devices
- Taconite duty modifications
- Special ratios
- Special paints and coatings
- Marine duty modifications
- Low and high temperature modifications

Integral Motor

- Explosion-proof enclosures
- Special voltages
- 2-speed motors
- High efficiency
- Inverter packages
- High torque "C" or "D" design
- Special frequency

Applications

- Mixer Drives
- Pugmills
- Package Conveyors
- Bulk Conveyors
- Sewage Treatment Drives
- Cross Collector Drives
- Clarifier Drives
- Water Screens
- Screw Pumps
- Roll Table Drives
- Scrap Choppers
- Slitters
- Pinch Rolls/Flatteners
- Pump Drives
- Servo Drives
- Woodyard Equipment

Delroyd

Worm Gear Reducers & Sets

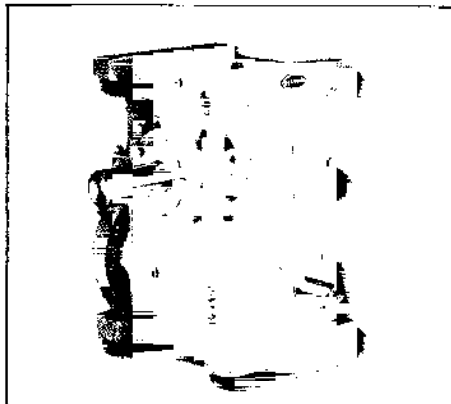

Single Worm Reducers

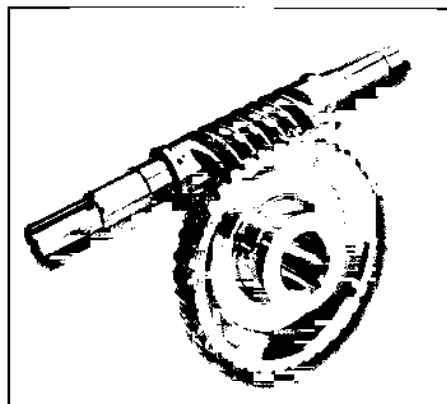

Worm Gear Set

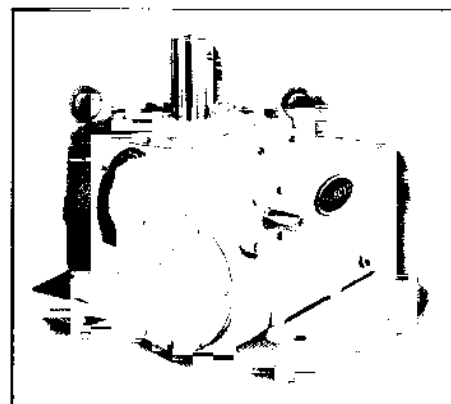

Double Worm Reducer

Delroyd Worm Gears

Delroyd worm gear speed reducers, helical worm speed reducers and worm gear sets are manufactured for reliability and long service life. Built for a variety of applications and configurations, Delroyd worm gears can be supplied as stand-alone units or in complete packaged drive assemblies for both mechanical and electrical components. Entire drive packages are available including reducer and motor mounted on a bedplate with couplings, coupling guards, backstops, chain and/or belt drives, clutches, shoe or disc brakes and auxiliary lubrication consoles. You receive it ready to run...not ready to assemble.

Advantages and Features

- Compactness and high ratio reduction
- Long, quiet life
- High shock load capacity
- Interchangeability of components
- Cast iron or fabricated steel cases
- Center distance from 2" to 48"
- 1,500 to 3,500,000 in. lbs. of torque
- Available without motors
- Right angle & parallel shaft arrangements
- Vertical & horizontal mounting
- Fan cooled
- Modifications and variations available
- Custom designs

Types and Sizes

- Single Reduction Reducers
5:1 to 70:1
- Helical-Worm Reducers
15:1 to 355:1
- Double Worm Reducers
75:1 to 4900:1
- Drives for Top-Entering Chemical & Process Agitators
5:1 to 100:1
- Open Gearing
5:1 to 70:1
- Special Reducers
Up to 125,000:1
- Special Open Gearing
Up to 180:1

Applications

- Hoists, mechanical jack and screw drives
- Log handling & debarking machines
- Grinding & threading machines
- Steel & paper mill machinery
- Sewage treatment equipment
- Chemical processing equipment
- Machine tools, elevators & pumps
- Mining machinery
- Drilling equipment
- Coal handling & pulverizers
- Cement mixers
- Winch drives
- Mixers & agitator drives
- Cable tensioners

Request Catalog D-400 and D-500

e-mail nuttall@nuttallgear.com

Gear Drive Service

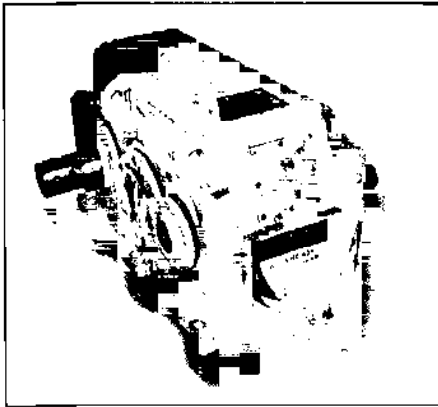

Before

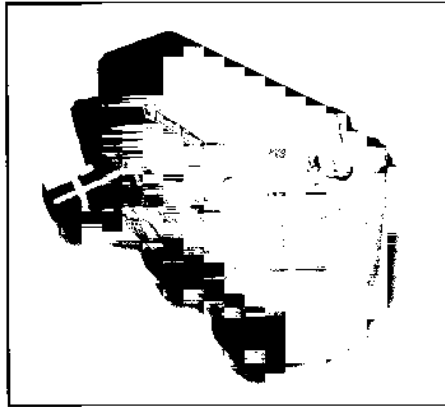

After

Your Total Service Source

Your business depends upon the continued operation of your rotating machinery. Nuttall Gear provides gear drives maintenance service combined with a quality product which are designed to keep your rotating machinery in operation. Our extensive experience in gear drive applications, coupled with the total manufacturing and design capabilities, enables us to provide you with a single, comprehensive source for improving your productivity.

In addition to our all inclusive service capabilities, we specialize in building complete mechanical and electrical packaged component assemblies. We can custom design and manufacture units to your unique requirements, utilizing years of experience in designing gear drives for a wide variety of applications.

Total Service Source means a commitment to quality and excellence in everything we do. Nuttall Gear is a company with a history of high standards and performance and we work to keep it that way. You can count on it.

Capabilities

- Repair and Rebuild
- Gear Refinishing
- Shaft Repair
- Rebabbiting Sleeve Bearings
- Cast Iron and Welded Housing Repair
- Complete Nondestructive Testing
- Complete Unit Assembly and Testing

Redesign and Rerate

- Ratio Change
- Increased Mechanical and Thermal Ratings
- Complete Redesign

Field Service

- Installation
- On-site Rebuild
- Trouble Shooting
- Mechanical Alignment

Field Consultation

- System Analysis
- Vibration and Sound
- Torsional System Study
- Lubrication
- Metallurgical Analysis

On-Site Seminars

- Preventive Maintenance
- Disassembly and Rebuild

Quality Assurance

Repair and rebuild service is planned and executed within the requirements of our Quality Assurance Program from inspection and tear down to reassembly and complete unit testing. Our Program was designed to meet the strict requirements of the nuclear power industry and the world recognized standards established by ISO 9000. Documented traceability for materials, processes, and testing is part of the Quality Assurance Program that applies to all service work.

Ameridrives® Couplings

PO Box 4000
Erie PA USA 16512-4000
Tel 814 480 5000
Fax 814 453 5891
www.ameridrives.com

Ameriflex® Diaphragm Couplings
Amerigear® Gear Couplings
Amerigear® Mill Spindles
Americardan® Universal Joints

Bay City Forge

PO Box 4000
Erie PA USA 16512-4000
Tel 814 456 2088
Fax 814 456 4395
www.baycityforge.com

Single and Multiple Crankshafts
Straight, Eccentric and Hollow Bore Shafts
Round, Square and Hex Bar Stock
Rolls, Spindles, Upsets, Rings and Disks

Industrial Clutch

PO Box 118
Waukesha WI USA 53187-0118
Tel 414 547 3357
Fax 414 547 2949
www.indclutch.com

Model LKB Low Inertia Clutches & Brakes
Model CBA/CBH Combination Clutch/Brake
Model HC, HBA, HBS Oil Cooled Clutches & Brakes

Marland Clutch

PO Box 308
La Grange IL USA 60525-0308
Tel 708 352 3330
Fax 708 352 1403
www.marland.com

Marland Backstops
CECON® Clutches
CEBMAG® Clutches
Marland RINGSPANN® Freewheel Clutches

Nuttall Gear/Delroyd®

PO Box 1032
Niagara Falls NY USA 14302-1032
Tel 716 731 5180
Fax 716 731 9329
www.nuttallgear.com

Delroyd® Worm Gear Products
Type TDS Parallel & Right Angle Shaft Speed Reducers
Moduline® Concentric Shaft Speed Reducers & Gearmotors
Type SU & Type SD High Speed Gear Drives
Type RV Right Angle Vertical Speed Reducers
Veri-Dri Vertical Concentric and Parallel Shaft Drives
Metals Industry Gear Drives
Custom Engineered Drives

Contact your nearest representative.

Boston
Gear

Printed in U.S.A.

INDUSTRIAL MAGZA®
DIST. AUTORIZADO

MEX (55) 53 63 23 31 MTY (81) 83 54 10 18
QRO (442) 1 95 72 60 ventas@industrialmagza.com